

JUICY

ELECTRIC BIKE
USER MANUAL

RIDE

THIS

WAY



ELECTRIC BIKES RIDE THIS WAY

User Manual

Please take time to read this guide to ensure top performance from your new Juicy bike and battery

Content sections

Quick start

Delivery inspection

Assembly

Good to know

Regular Adjustments

Assembly Checklist

Before riding

Riding your e-bike

Lithium Battery care

Warranty and returns policy

Quick Start

If your bike has been checked over by someone competent and you're ready to ride, here's how to switch it on:

1. **Switch on the battery:** turn the key clockwise, all the way to the right (Position 3). **NOTE:** Roller, Ticket & Lift batteries switch on automatically.

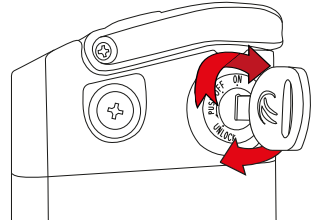

2. **Switch on the display:** press and hold down the **middle** button. To alter the level of pedal assist which is given, simply press the plus or minus buttons whilst stationary or pedalling.

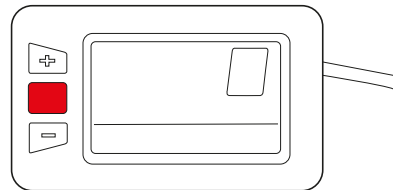
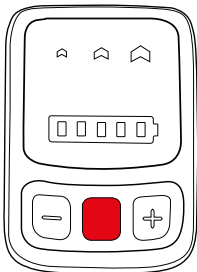

3. **Light Operation:** The front light is connected into the system and powered from the battery. To operate, press and hold the  button for 3 seconds and release. The **rear light** has its own battery and **switch**:

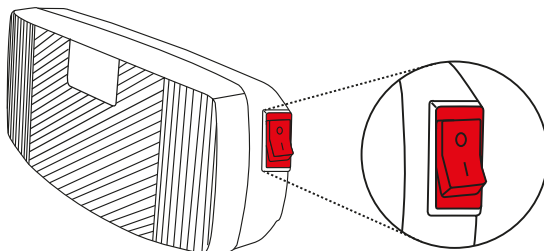

Speed settings

1. **Gears:** Pedalling can be made easier by **changing gear**, as you ride...

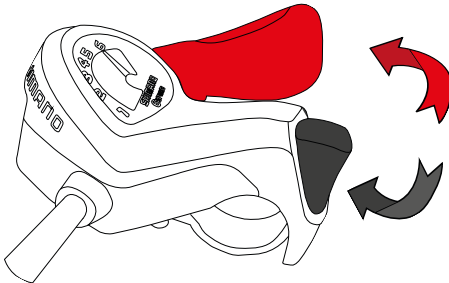

Push lever to lower gear ratio whilst pedalling up-hill

Push button to increase the ratio for level riding

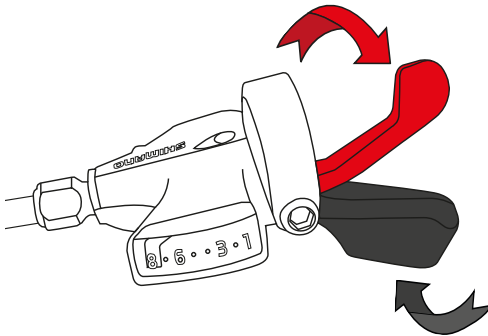

Click paddle shifter to increase the ratio whilst pedalling

Push paddle shifter to lower the ratio whilst pedalling

2. **Pedal Assistance:** To alter the level of assistance simply press the plus or minus buttons whilst stationary or pedalling. The standard **LED Display** (Left) has 3 levels of assist, the upgraded **LCD Display** (Right) has 5.

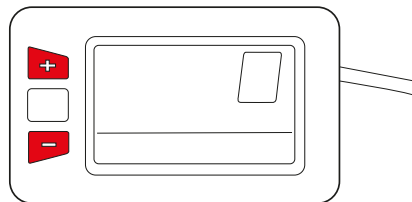
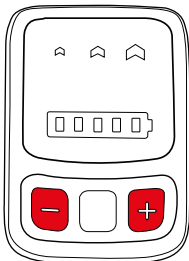

3. **Walk assistance:** Our latest displays offer a low speed “cruise” setting, for use when walking alongside your bike. To activate walk assist, **hold down** the – button. After a few seconds the bike will start.

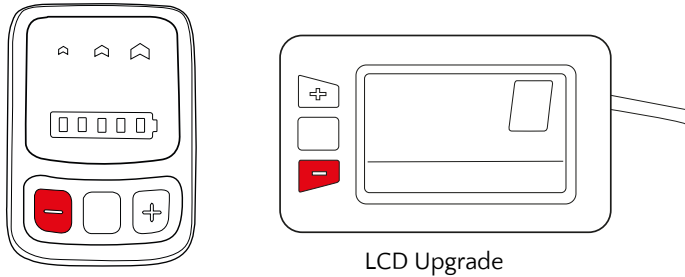

For bikes with a throttle, the red button is depressed and the throttle grip twisted to activate. For safety, when not in use ensure the red button is left out to avoid accidental use of the throttle.

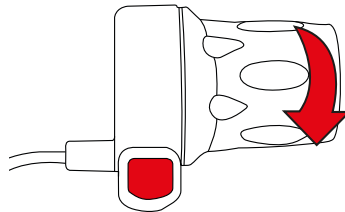

There is a specialist manual for the LCD upgrade display at Juicybike.com (in our Aftercare section.) You can find the latest version of this manual there too.

Before riding you should read the section entitled: “Riding your e-bike”.

Delivery inspection

If your bike has arrived boxed, then follow these guidelines for assembly.

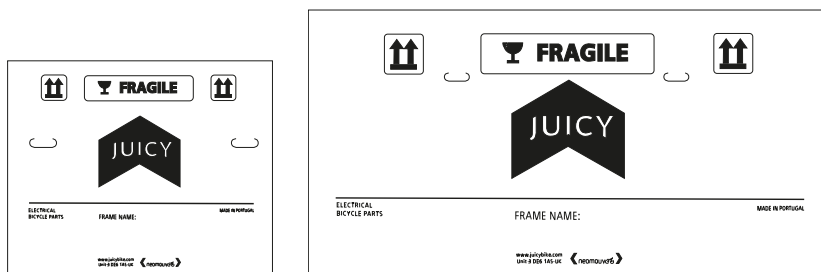

If you have taken delivery of a Juicy Bike via a courier **please carefully inspect the packaging** for any signs of damage or mishandling.

We insure all bikes against damage caused during transport via couriers, but this insurance ceases once you accept the carton. **If in any doubt** sign any delivery note as "not yet inspected" to preserve your right to claim for damage caused in transit from us to you.

Inside the carton you should find the **main frame and wheel assembly (including lights)**, **seat** and **post**, charger box containing your **battery charger**, and **pedals**. The battery should be locked into its frame compartment. The handlebars in some instances may be strapped to the side of the bike.

All the main parts will have been carefully wrapped and protected when first put into the carton. You should keep the wrapping materials and the carton itself, just in case you need to return the bike to us.

Tools Needed:

A good set of **Hex keys**, an **adjustable Spanner** and a **Philips screwdriver** should be all you need to assemble your bike.

Ideally...

Allow yourself plenty of time to put your bike together carefully.

You should be confident that you have the skills required to safely prepare the bike for use and are able to carefully check that everything functions correctly and safely, before using the bike. It is not expensive to have your bike assembled at a local bike shop where you should find experienced and responsible bike mechanics, so if you have any doubts consider using a professional.

At a bike shop your bike would be assembled using a purpose-built stand, at eye level. At home a bench or table with space all around is a good place to build, especially if you have a friend that can help hold the bike. Kneeling around a cluttered floor is not ideal!

Clear some space and make plenty of time to complete a careful assembly.

A cup of tea might also help...



Assembly

1. **Handle bars:** larger bikes arrive with handlebars flattened to fit in the carton.

To correctly align the handlebars, lift the adjuster and rotate forwards to reveal the hidden bolt. Loosen the bolt using either a 5mm or 6mm hex key until the handlebars swivel freely. Dependent on the type of stem, you may also need to loosen the bolts on either side of the handlebar stem.

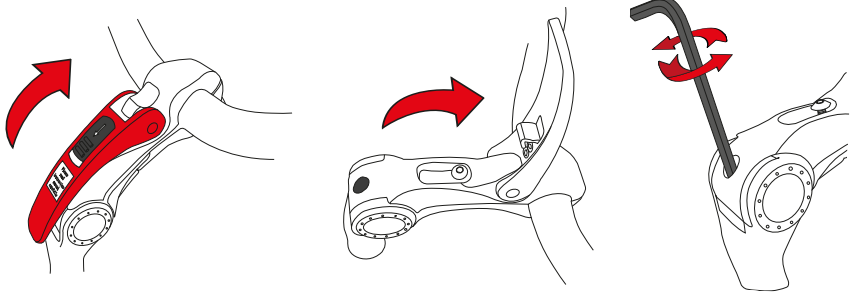

For bikes with a fixed stem, handlebars will be attached to the side of the frame. Avoid releasing the handlebars from the frame until ready to fit them. Leaving them dangling will place strain on the cables.

First, loosen 2 bolts either side of the stem then rotate to face forwards.

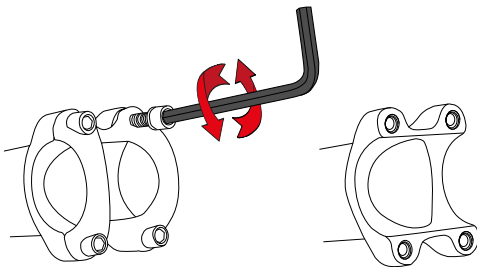
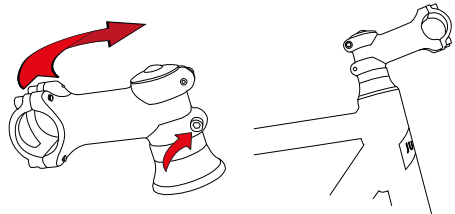

Next, use a 4mm Hex Key to remove all 4 bolts and plate from the front of the stem.

Now is the perfect time to release the handlebars from the side of the frame and place them in the stem. Loosely screw the bolts and plate back onto the stem, finger tight.

Working in sequence 1 then 2, 3 then 4, tighten each bolt by a half turn before moving on to the next allowing each bolt to be tightened evenly, until all are tight and the handlebar will not rotate in the stem.

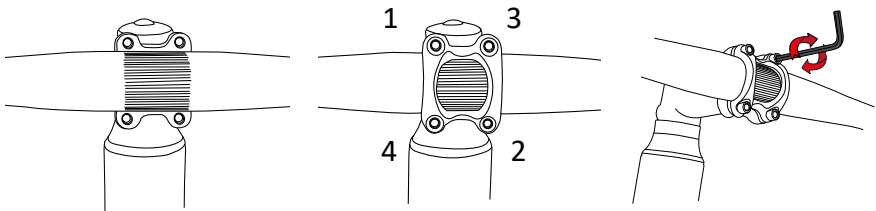

Ensure the handlebars are perpendicular to the front wheel. **Top Tip:** A boarded or tiled floor can help with alignment.

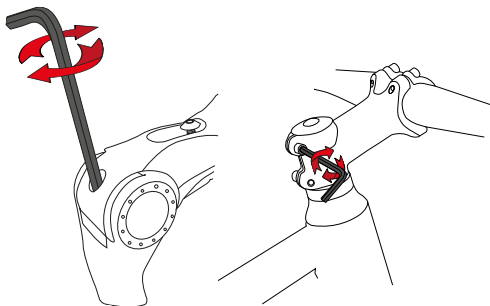
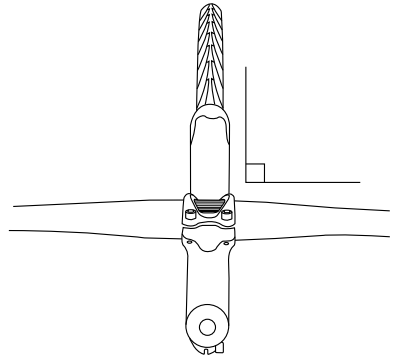

When you are happy all is square, fully tighten any loosened bolts.

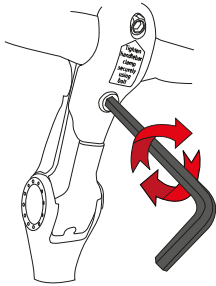

If the handlebars are not holding firm under pressure, the grip may also need tightening. This can be achieved by tightening the bolt underneath the front of the adjuster clamp.

For bikes with mono-shock suspension (Roller, Compact Plus):

First the forks need to be pulled up into the frame (1) then the handlebar stem clamped tight (2)...

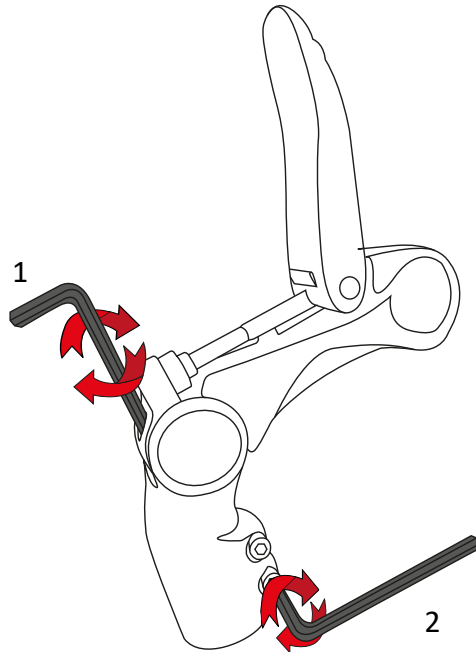
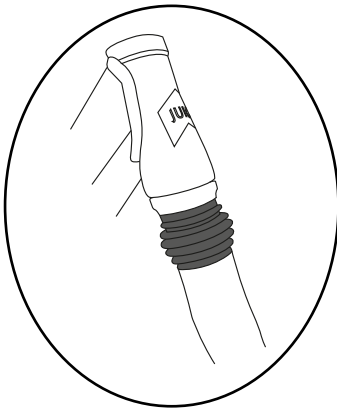

Pedals: To avoid damage during shipping, pedals are not pre-installed onto the cranks. **They look identical, BUT** the two pedals with your bike are one for the right foot, the other for the left.

Important, First, identify the pedals. Each pedal will have either an **L** for **Left foot** or **R** for **Right foot** etched into it (See image).

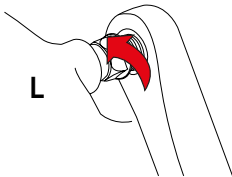
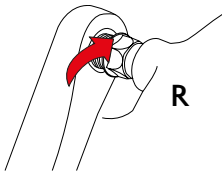
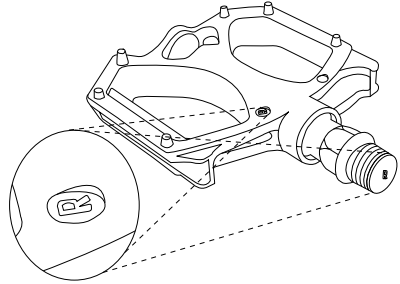

Using finger & thumb (and later a 15mm spanner) attach the pedals onto their crank arms. The **R** pedal will be tightened in a **clockwise** direction.

The **L** pedal is counter threaded, tightened in the **anticlockwise** direction. This helps ensure pedals do not loosen whilst riding.

Each pedal should easily catch its thread and force should **never** be used to begin to engage.

If the thread is not easily engaging, remove the pedal, realign and try again. The pedal should

be inserted until it is tight with a short standard spanner. Take care to not over-tighten. Once they have been installed, give them a spin to ensure they are rotating as they should.

Top Tip: Keep the pedal square with the crank. If the pedal is square it is really hard to cross thread. Cross threading takes force – so, **if force is required something is about to become broken...** loosen, remove, start again.

2. **Folding bike assembly:** Our Compact range of folding bikes could not be easier to assemble. Simply remove all of the packaging and unfold your bike and attach your pedals. It really is that simple!

For a handy reminder of how the folding mechanism fully works, head to juicybike.com where you can find a video explaining each and every step in detail.

Good to know...

1. **Front wheel removal and replacement:** Front wheels for our larger bikes come with quick release (QR) mechanism.

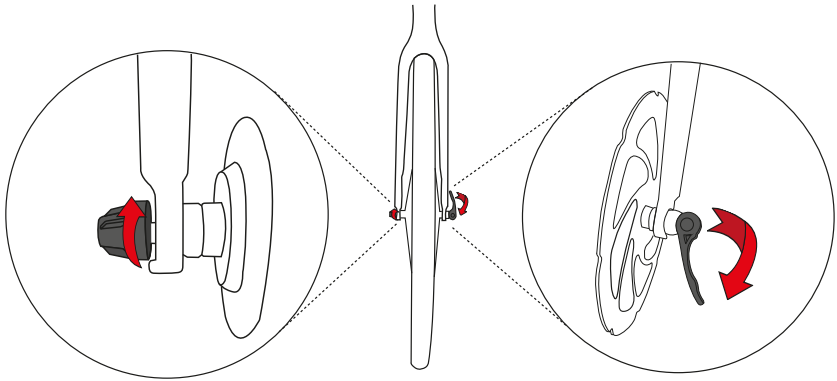

With the lever open, the nut is used to both loosen and pre-tighten the mechanism.

To remove the front wheel, unscrew the nut until the wheel drops out freely.

When reinserting, ensure the wheel is sitting true within the forks, tighten the nut and close the lever so that it can be closed very firmly with the palm of your hand. Check the wheel is running true and if not, loosen and repeat the process carefully.

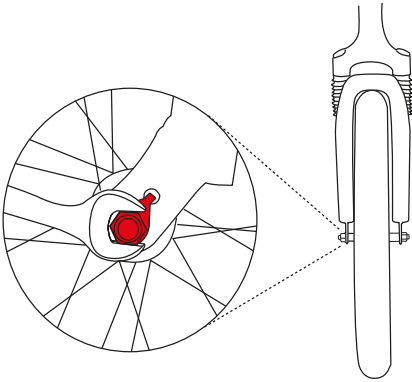

Our Compact bike front wheel is fitted with a standard nut and locating washer. Making sure the small washer locates into the forks, tighten using a 15mm spanner and again be sure to **always** check the wheel runs true, centred within the forks.

- 2. Seat Post:** Is easy to adjust, simply unfold the quick release lever, or loosen the bolt, and retighten once you have found your perfect height.

Do make sure it cannot twist or droop whilst riding by tightening the adjuster. There is a mark showing the maximum height upto which the post may be set. **Do not exceed this max height.**

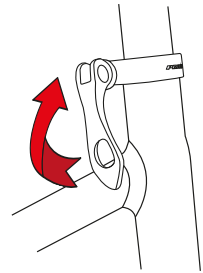

- 3. Charging the battery:** Be sure to fully charge your battery, before going for on your first ride. The charger light will change from **red** to **green** when the battery is fully charged. Then switch off and remove the charger.

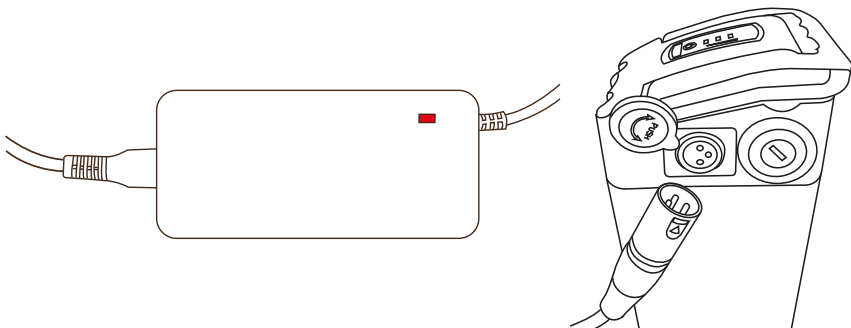

4. **Removing/replacing the battery:** Some of the batteries in our range can be charged in or out of the bike. Push in and turn the key fully anti-clockwise to unlock the battery from the bike. Take care putting the battery back into the bike.

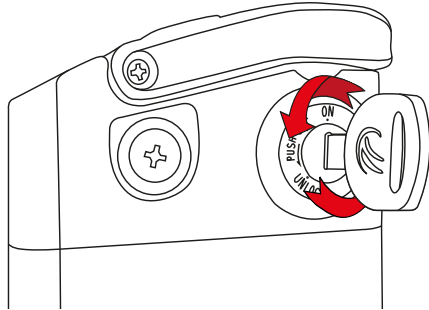

To replace the battery, First ensure the slide rail is positioned into the battery groove. Once aligned slowly slide the battery onto its pins ensuring there is nothing obstructing its path.

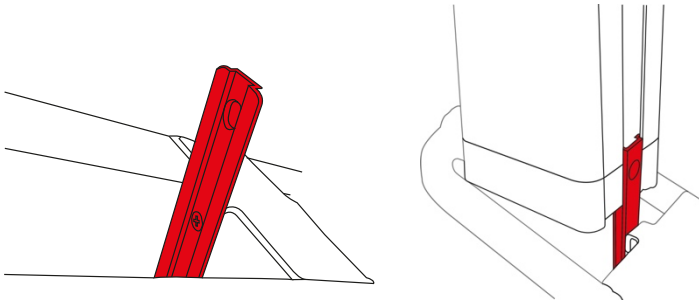

Once fully inserted, turn the key **clockwise** into the **OFF** position to lock the battery in place. The key can then be removed.

Regular Adjustments

1. **Mechanical Disk Brake adjustment:** Your brakes will need regular attention to ensure they operate correctly. As the pads get used you will need to adjust them to stay close to the metal rotor. A bike shop is the best place to have your brakes checked and adjusted, but if you need to do this yourself here's how.

Every few months (depending on use): Looking through the spokes you will see the inner pad adjuster. Using a hex key and rotating in a clockwise motion, move the **inner pad** closer to the disk rotor. If you can hear the disk rubbing after adjustment, rotate anti clockwise in increments until the rubbing can no longer be heard.

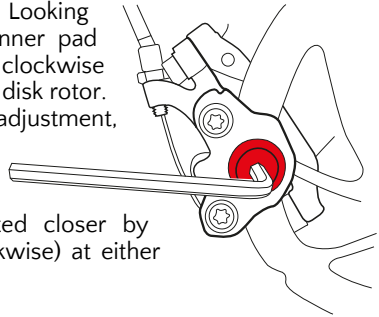

The **outer pad** can be quickly adjusted closer by unwinding the cable adjuster (anti-clockwise) at either the brake lever or at the calliper.

Specialist equipment is needed to adjust hydraulic brakes and is recommended that a professional service is carried out in these situations.

2. **Gear Adjustment:** A noisy gear, or poor gear selection, is often because the chain is not lined up precisely with the cogs. Looking from the back of the bike, line up the chain using the adjuster. First select and line up the chain with the highest gear (smallest cog). Turning **clockwise** guides the chain to the right, **anticlockwise** to the left. Once the highest gear is aligned, test to see if the gear change is smoother. If the problem persists, it's probably time for a service.

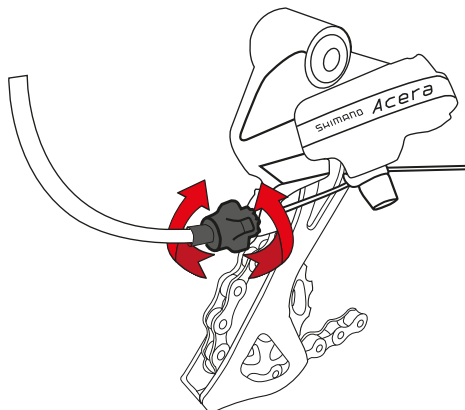

Finally... check everything.

This checklist helps make sure your bike is properly assembled and safe to ride:

Handlebars

- Ensure handlebars are straight and secure and all bolts are tight. To check, tightly grip the front wheel between your legs and try to turn the handlebars.

Wheels

- Ensure the front and rear mudguard stays are tight.
- Check that the quick release mechanism is properly gripping the front wheel.

Seat and post

- Ensure that the seat is straight and secure and does not exceed max height.

Pedals and chain

- Check the pedals are wound in fully and tightened.
- Ensure gears engage cleanly and their adjustment is correct

Brakes

- Test front and rear brakes whilst rolling the bike forwards – both wheels should stop completely.
- Test there is more than a finger's-width space between the grip and the brake lever when fully depressed.

Rack

- Ensure that the rack is secure and that all bolts are tight.

Kickstand

- Ensure the kickstand doesn't wobble. Tighten its bolt on the frame if necessary.

Tyres

- Pump tyres to very firm (impossible to deform with your thumb nail). Actual PSI can be found written on the tyre side wall, typically greater than 50lbs sq in.

Electrics

- Test both lights.
- Fully charge the battery before use.

Before riding:

- ✓ Adjust the height of the handlebars and saddle to suit the rider, whose toes should be able to just touch the ground.
- ✓ Check all lights and displays are working.
- ✓ Check regularly to ensure that the electrical connectors between the bike and battery are clean.
- ✓ Check the brakes: this can be done by putting the front brake on and pushing forwards. Do the same with the back brakes. The bike should not move and the brake levers should not touch the handlebars. The brakes should work without having to press down too hard on the handles.
- ✓ If your bike has a quick release on the front wheel check it is fully tightened and the wheel is running true. Quick release mechanisms can more easily work loose than conventional axles and so should be checked before every ride.
- ✓ Make sure your clothing is suitable for riding. Long, loose or flowing garments may become caught in the wheels or chain.
- ✓ Wear an approved safety helmet.

Riding your e-bike:

- After mounting the bicycle, turn on the main switch, the power display light will come on, indicating power is connected. Release the kickstand.
- Placing one foot ready to pedal, **check that it is safe to proceed**, and then set off. You will feel the motor just after you begin to pedal.
- As you cycle, the battery power will be used up, and the power level indicator lights will go off in turn. If the battery becomes flat, turn off the main switch and use pedals only to ride, recharge fully after journeys have accumulated over 10 miles.
- Use both brakes together when stopping.
- When riding in wet conditions your brakes will be less effective and a greater stopping distance is needed. In dry conditions your stopping distance should be less than 4 metres; this can increase to 15 metres on wet or snowy roads.
- **Never ride through deep puddles** or streams. Ensure that water **never** reaches the motor and controller level.
- Avoid loose or uneven surfaces, up and down kerbs and watch out for unexpected pot holes.
- Don't carry extra passengers or heavy loads, as this will damage the motor and battery.
- Never ride under the influence of drugs or alcohol, or when feeling unwell.
- Always ride with lights at night, and in daytime lights help to be seen.
- The minimum legal age for riding an electric bicycle in the UK is 14 years.
- Please follow the Highway Code for the safety of yourself and others.
- If you are new to cycling or an inexperienced rider, find a quiet place to practise and gain confidence before trying to ride on busier roads. Buy a copy of the Highway Code; most good newsagents have it.

Cycle training courses for adults and young people are run nationally. For more information call the cycle training hotline on 0870 607 0415 or visit www.ctc.org.uk

Bike storage and maintenance:

- Don't leave the bike in the rain for long periods, or in damp conditions: always store in a dry place.
- Don't leave the bike in direct sunlight for long periods, as this may cause some of the electrical components to overheat and result in operation failure.

Warning:

- Don't tamper with, or disassemble complex electrical components.
- Don't touch the bottom of the battery case with keys or other metal objects in case they damage the electrical connectors between the bike and battery.

Keep your bike clean

- Use a degreaser detergent, or a specialist chain-cleaning product to clean and oil your chain. A properly cared-for chain can make a bicycle more than ninety eight per cent efficient at converting kinetic energy into moving your bike forward. Juicy Bike chains are stainless steel and need very little oil. Too much oil can pick up grit and so increase wear. We recommend Green oil's, Clean Chain degreaser and a little Chain Lube.

Check tyres, brakes and gears monthly

- Check the tyre pressure; make sure it is enough at least 40 PSI and preferably 50 (Compact) or 60 PSI. Low tyre pressure will make the bike less efficient and will easily damage the tyres.

Brake adjustment

- Brake levers should operate the brakes easily with only a small amount of travel at the handlebars. If there is not enough room for two fingers between the lever and the handlebars then adjustment is essential. See how to adjust above.

Chain adjustment

- The chain may become looser after a long period of use and can only be adjusted by removing links, which is best carried out at a bike repair shop.

If you are unsure about brake, gears or chain adjustment, take the bike to be serviced at your local cycle shop.

Lithium Battery Care

You should fully charge your new battery before your first ride.

In regular use, keep the battery fully charged after every few short rides. If possible try to keep the battery between 50 and 95% charged, charging after 10 miles or so.

Make sure you charge at least once every month.

Try to charge just before a journey, rather than keep your battery at 100%.

Letting the battery run empty on most rides will shorten its lifespan considerably – it would be better to plan regular journeys to use about 50% of your battery.

Never charge the battery in **freezing** conditions. If the battery has been used in very cold conditions, let it warm to room temperature before charging.

If storing the battery for any length of time without use (over the winter say), try to keep it at around 60–80% charge, in a cool place inside, and top up the charge a little every month. This will decrease the aging process of the battery (although every battery will slowly age whether used or not).

Lithium batteries deteriorate more quickly when stored at higher temperatures and when repeatedly fully discharged.

When returning to use, charge the battery fully to prepare it for everyday use. Keep your battery out of the weather whilst not riding the bike, preferably in a cool place inside.

Always use the charger supplied with the bike. Before charging, check that the rated input voltage matches the voltage level for your country. (For the UK it is 240V/50 AC)

Don't open the charger case for any reason.

To recharge the battery: tip up the seat, unlock the battery, remove and connect to charger. Alternatively the battery can be recharged while still in the bike, just make sure the bike is switched off.

A full charge can take between 4 to 6 hours before the red charging light turns green. The charger will get quite warm whilst charging. When the light changes from red to green the battery is fully charged. After charging, disconnect the charger from the battery.

Always charge the battery indoors and away from damp areas or where water is used. When charging keep both the battery and charger away from flammable materials or products.

Our lithium batteries, if treated correctly, will have a long life. At the end of its life, the battery should be recycled and a replacement can be bought from www.juicybike.co.uk

The battery is deemed to have reached the end of its life when achieving only 40% of its original capacity.

Warranty and returns policy

Our Juicy Bike warranty is clear and simple:

Main parts have a warranty of one year. This covers mechanical and electrical parts: including frame, forks, seat, motor, controller, battery and charger.

The warranty is subject to proper care for and reasonable use of the bikes. Bulbs, brake pads, inner tubes, tyres, chain, cables, etc. are regarded as consumables. When replacements are required these can be purchased from your local cycle shop.

Returns Policy (UK)

We hope you will be pleased with your purchase. Should you wish to return anything bought from us, we will be happy to refund or exchange a product provided it is in fully resalable condition.

Returns should be made within a reasonable time (usually 14 days) and in original, undamaged packaging. If we find that the product has not been returned to us in fully resalable condition, we reserve the right to refuse a refund on the item, or deduct a reasonable amount of the original selling price from the refund.

Any refund will cover the cost of the goods, but will exclude the non-refundable delivery charge. The cost and risk of returning goods is the responsibility of the customer. The customer should arrange shipping back to Juicy Bike and ensure that any parcel is adequately insured.

Faulty Goods

Faulty goods notified to us **WITHIN 14** days of delivery will be collected, repaired or replaced, and redelivered free of charge. Note: At our discretion we may decide to issue a full refund instead of providing a repair or replacement.

Faulty goods notified to us **AFTER 14** days and within the warranty period are to be returned to Juicy Bike at the expense and risk of the customer. The customer should arrange their own shipping back to Juicy Bike and ensure that any parcel sent to us is adequately insured. Goods that are repaired or replaced under warranty will be re-delivered free of charge.

Note: At our discretion we may decide to issue a refund instead of providing a repair or replacement.

Terms and Conditions

Refunds are dependent on the condition of the goods received back. Damaged or incomplete goods will not be refunded in full. Goods damaged as a result of misuse will be subject to a repair and redelivery charge. The customer will be advised of all chargeable repairs before such work commences.

Repairs or replacements will be made free of charge within the warranty period only where the fault is not caused by misuse of the product or through normal wear and tear.

Parts and Servicing:

We provide one year's return to base warranty on all key electrical parts: motors, batteries and specialist components, subject to proper care for, and reasonable use of the bikes.

We stock [specialist spare parts](#) and batteries so you will always be able to maintain your bike and keep it in tip-top condition.

Specialist parts can be ordered at: www.juicybike.co.uk/ebike-aftercare/juicy-bike-parts

Other parts can always be found in any local bike shop.

For help and technical support please call 01335 388 035

or email us at uksales@juicybike.com

Finally

Juicy Bike are proud to be active members of the **British Electric Bike Association** and the **Bicycle Association of Great Britain**, and as such actively campaign for the more widespread use of electric bikes and for cycling in general.

BEBA regularly attend meetings with the Dept. of Transport in the UK and help advise on policy and make recommendations for the future design and safe use of electric bicycles. BEBA also publish guidelines about what purchasers of electric bikes should expect from suppliers and Juicy Bike are proud to adopt that **Code of Conduct** as a leading UK supplier.

You can find the BAGB website at <http://www.bicycleassociation.org.uk/>

All Juicy Bikes conform to the guidelines and standards set out by UK and European Law and in particular conform to the EVS-EN 15194:2009 standards for Electric Bikes, fulfilling the requirements of Electromagnetic Compatibility 2004/108/EC and where appropriate are provided with EU wide Certificate of Conformity documents allowing approved use on UK and EU roads and public highways.

We take our responsibility for providing safe transport very seriously, and use great care in the way our products are designed, manufactured and sold.

If you feel our products or service have not met the standards you expect, or feel we could do better in any aspect, please contact us. We value customers input and take heed of all feedback. You can contact us by post:

Juicy Bikes, Henmore Trading Estate, off Mayfield Road, Ashbourne DE6 1AS, by phone: 01335 388 035 or by email via our website, <https://www.juicybike.co.uk> or direct: uksales@juicybike.com